

Hieronder vinden jullie een leerrijk filmpje over 'de postbode'.

<https://schooltv.nl/video/hoelahoep-postbode/#q=postbode>

Dit filmpje kan je bekijken ter voorbereiding van de opdracht 'logische volgorde de weg van de brief – een tekening voor oma'.

## Een tekening voor oma



Knip de zes foto's op de volle lijn uit en leg ze in de goede volgorde.



## Schrijfdans

Video-uitleg via loom:

<https://www.loom.com/share/c53a7d9e033d4cedaac035ffb909d1be>

## Schrijfdans pakje: VIERHOEK

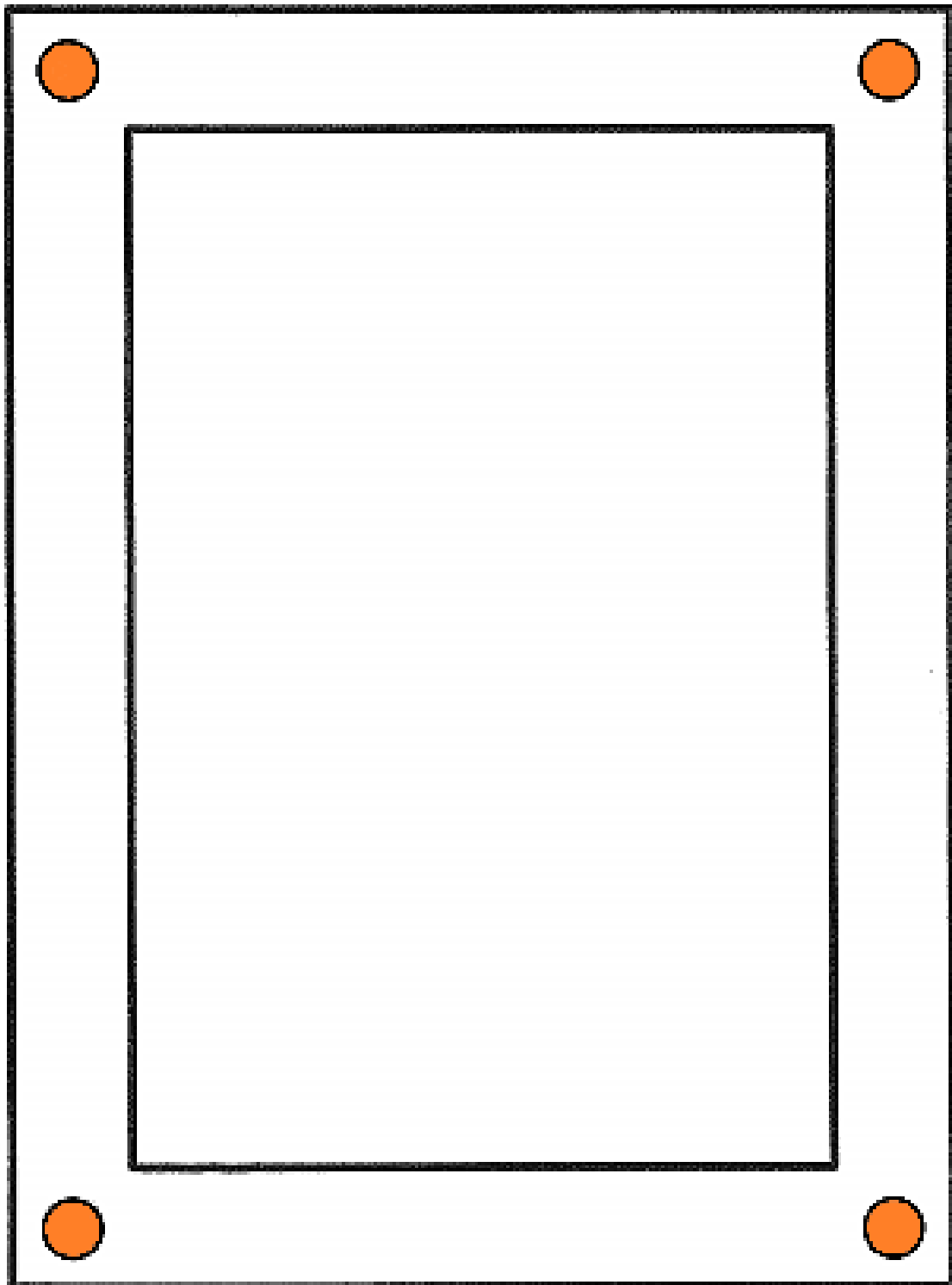

Schrijfdans pakje: DRIEHOEK

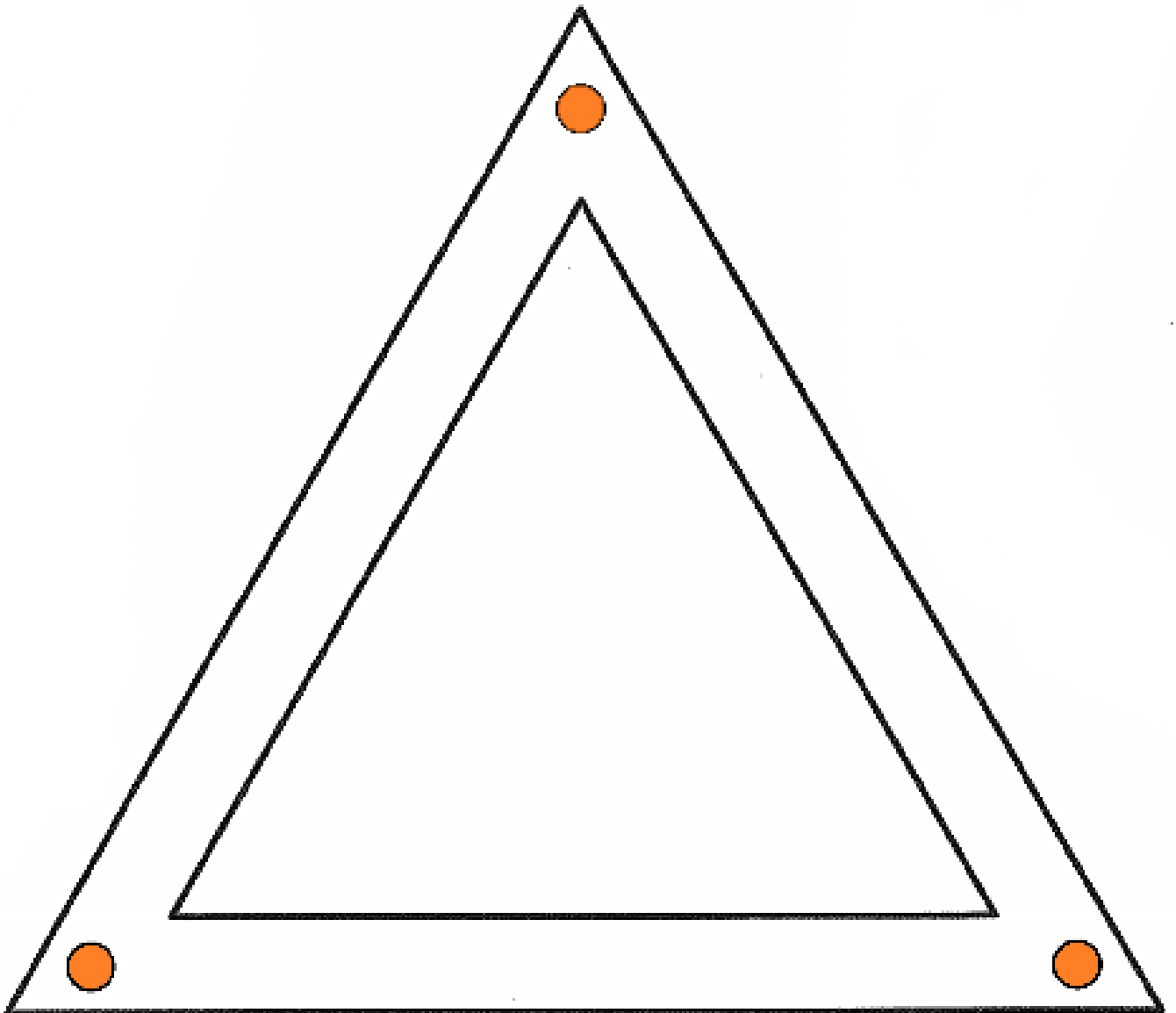

Schrijfdans pakje: CIRKEL

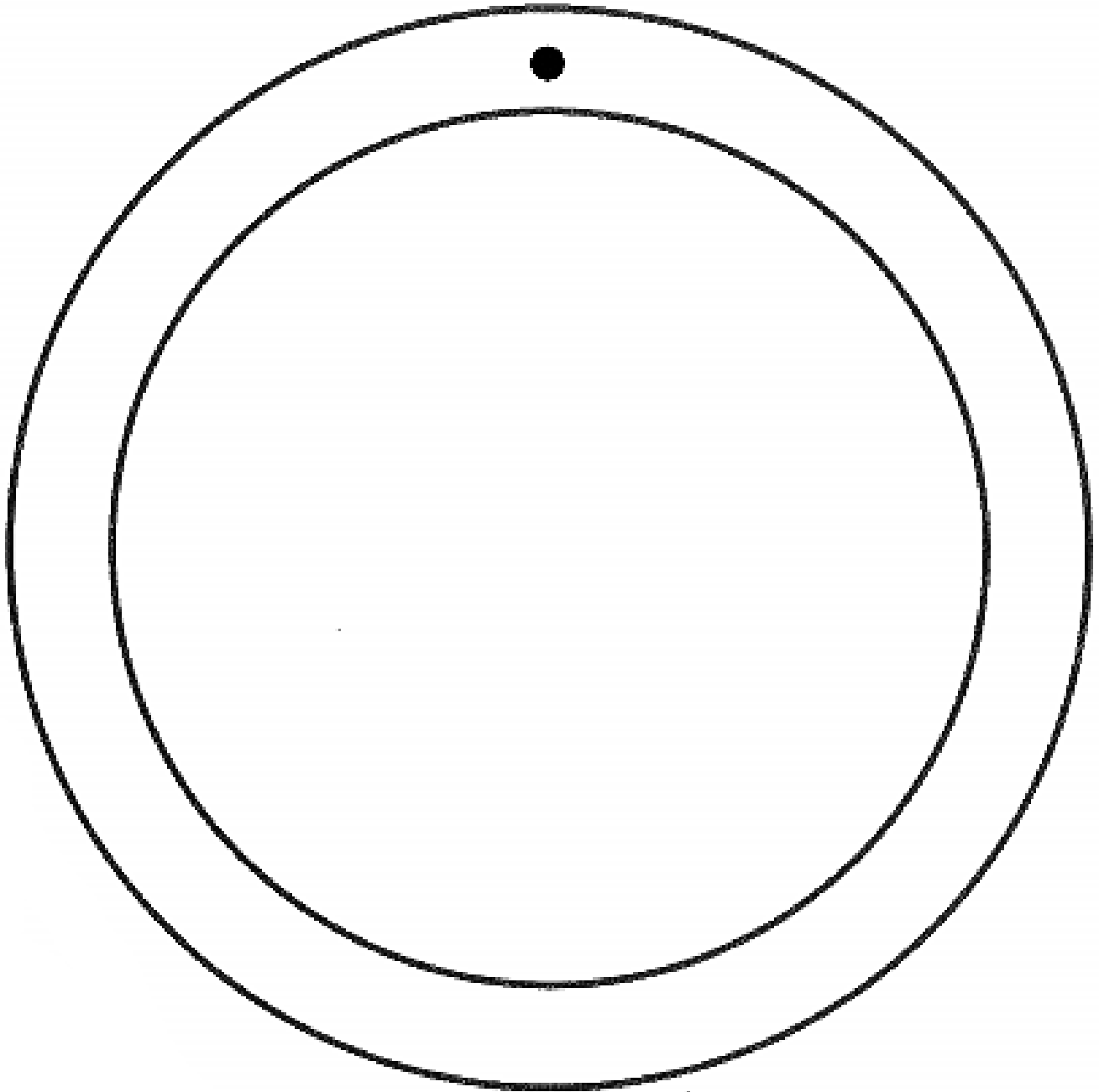

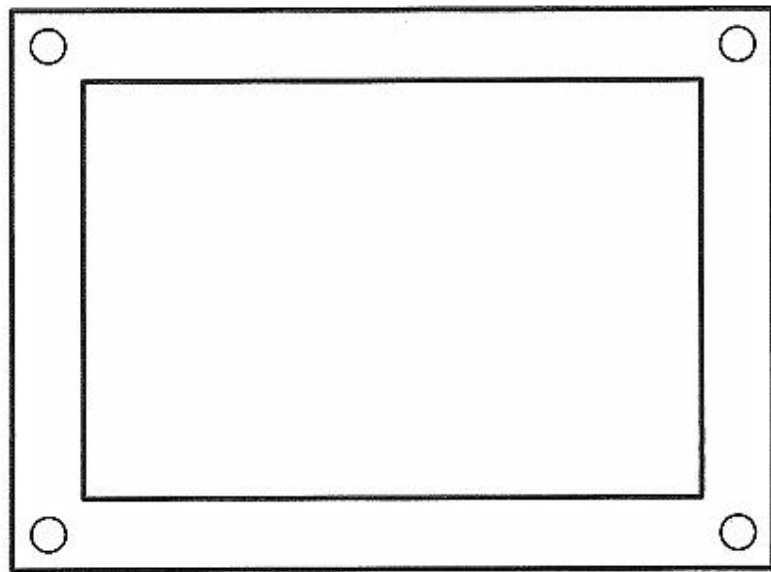
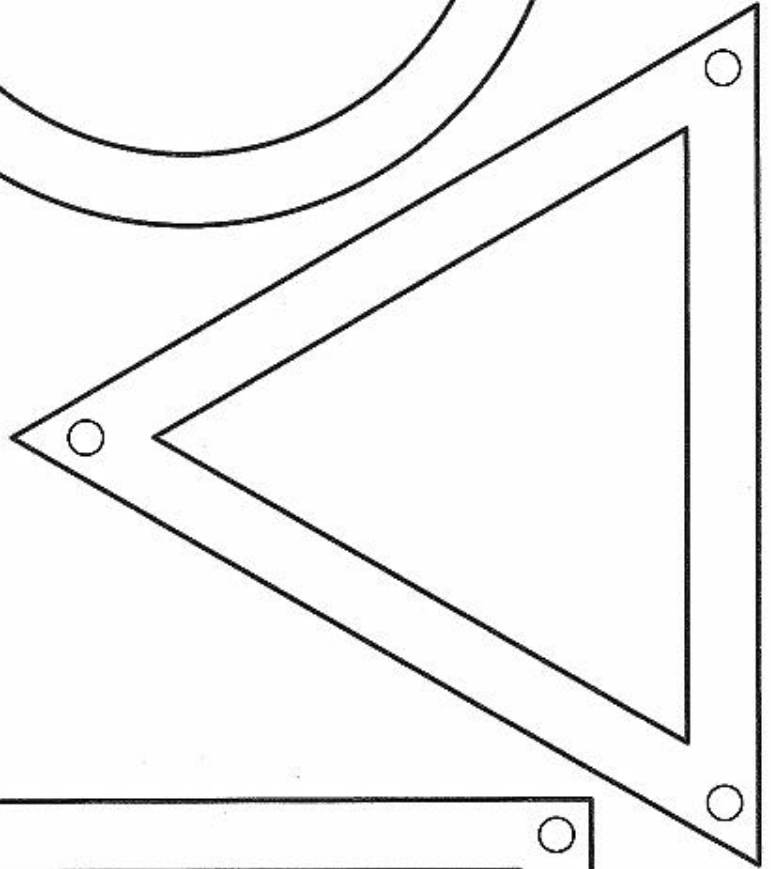
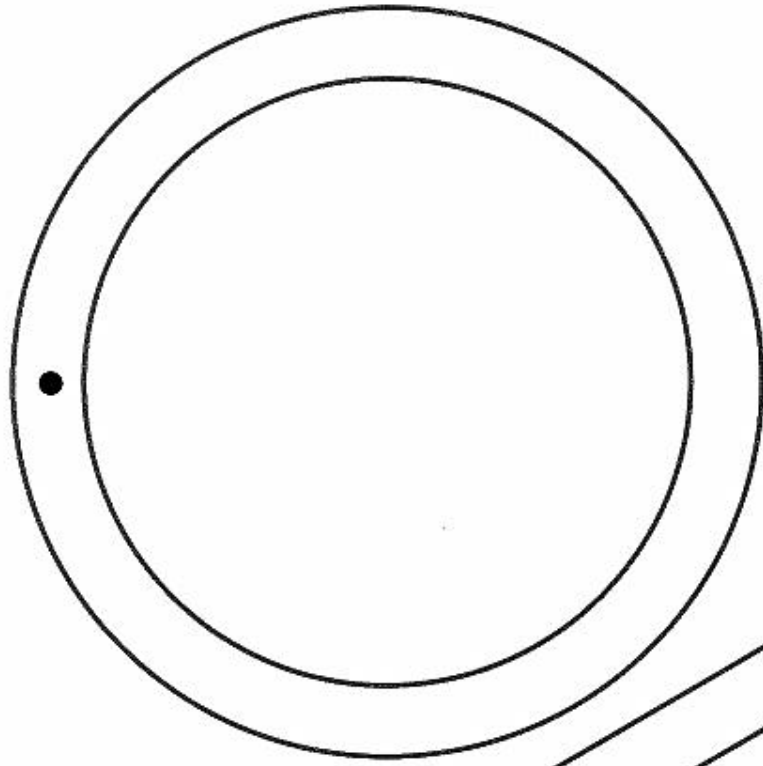
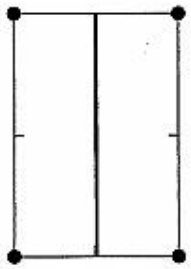
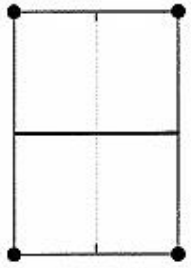
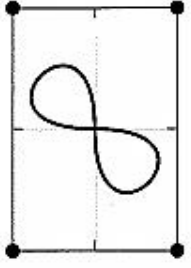
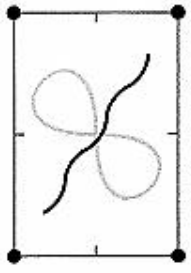

## Ordenen van klein naar groot

Knip de prentjes uit.

Leg de dozen van klein naar groot.

Makkelijk = met 3 prenten

Wat moeilijker = met 4 prenten

Moeilijk = met 5 prenten

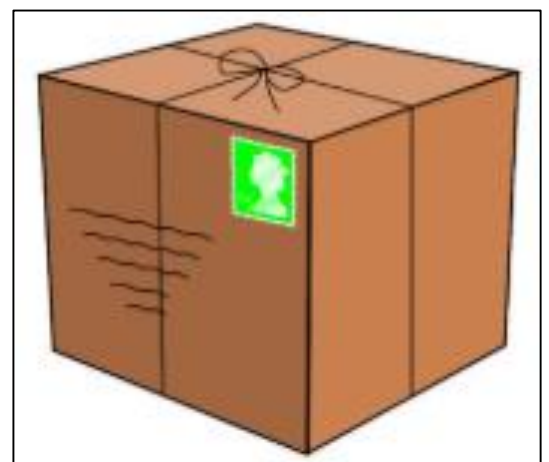
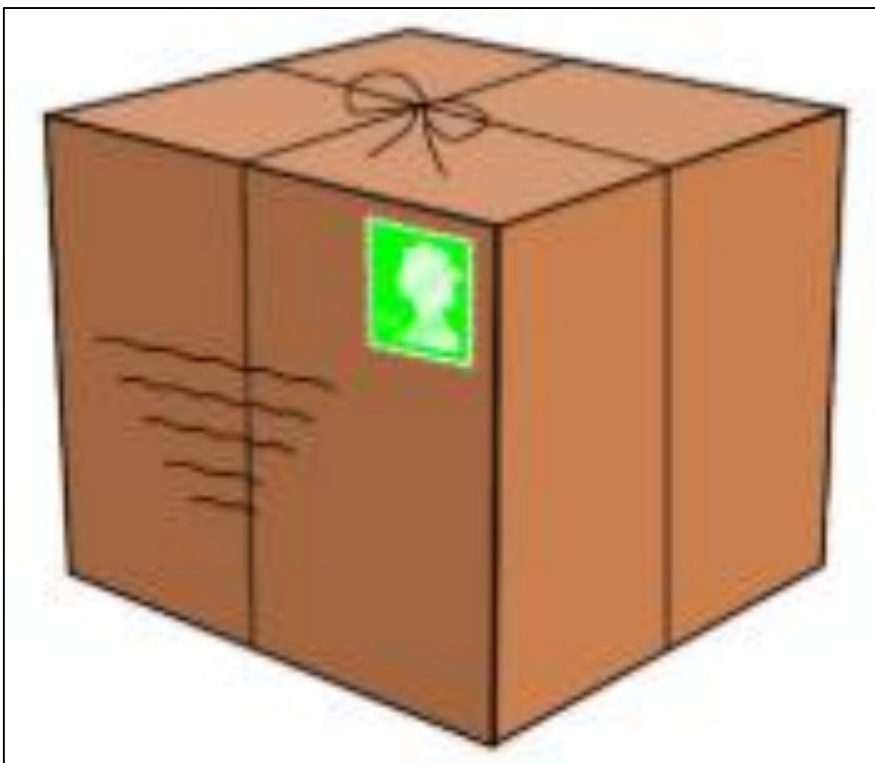
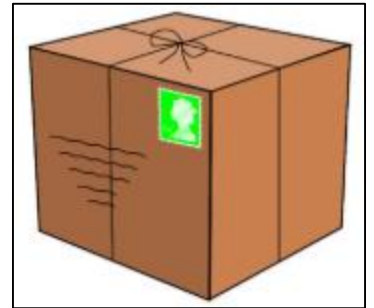
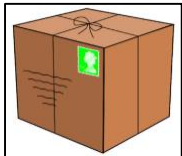
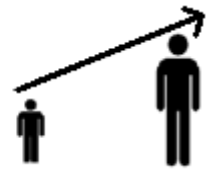

## **Knikkerspel**

Probeer de post (knikkers) naar de huizen te brengen. Beweeg de doos heen en weer om de knikkers te laten rollen.

**Tip:** wie geen knikkers heeft kan ook parels, steentjes, balletjes maken van aluminiumfolie,...

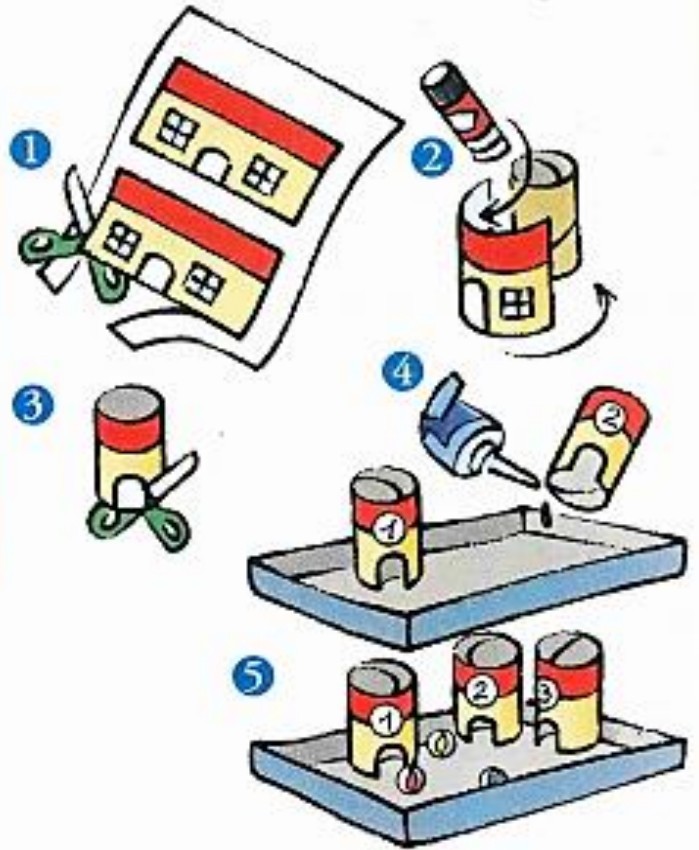

**Materiaal:**

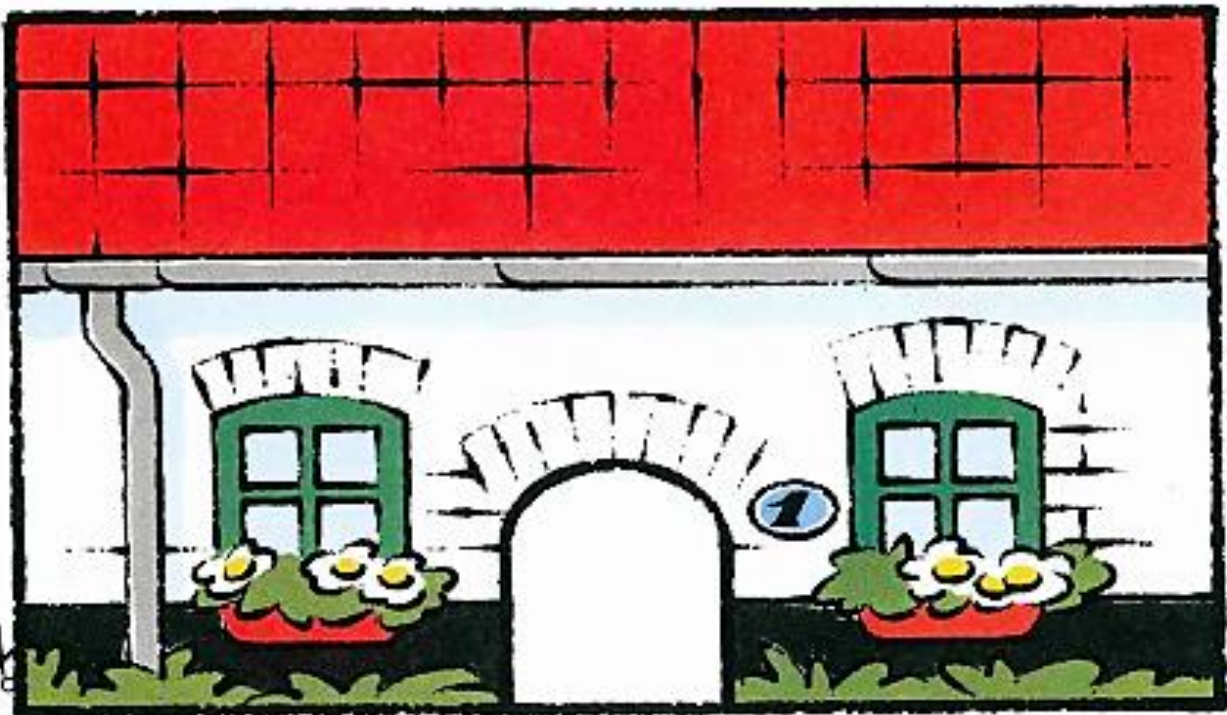
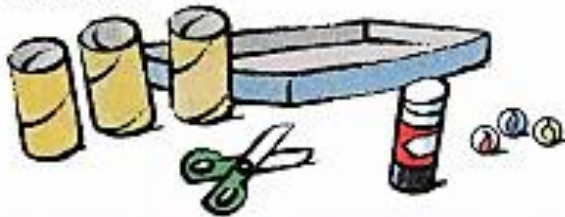

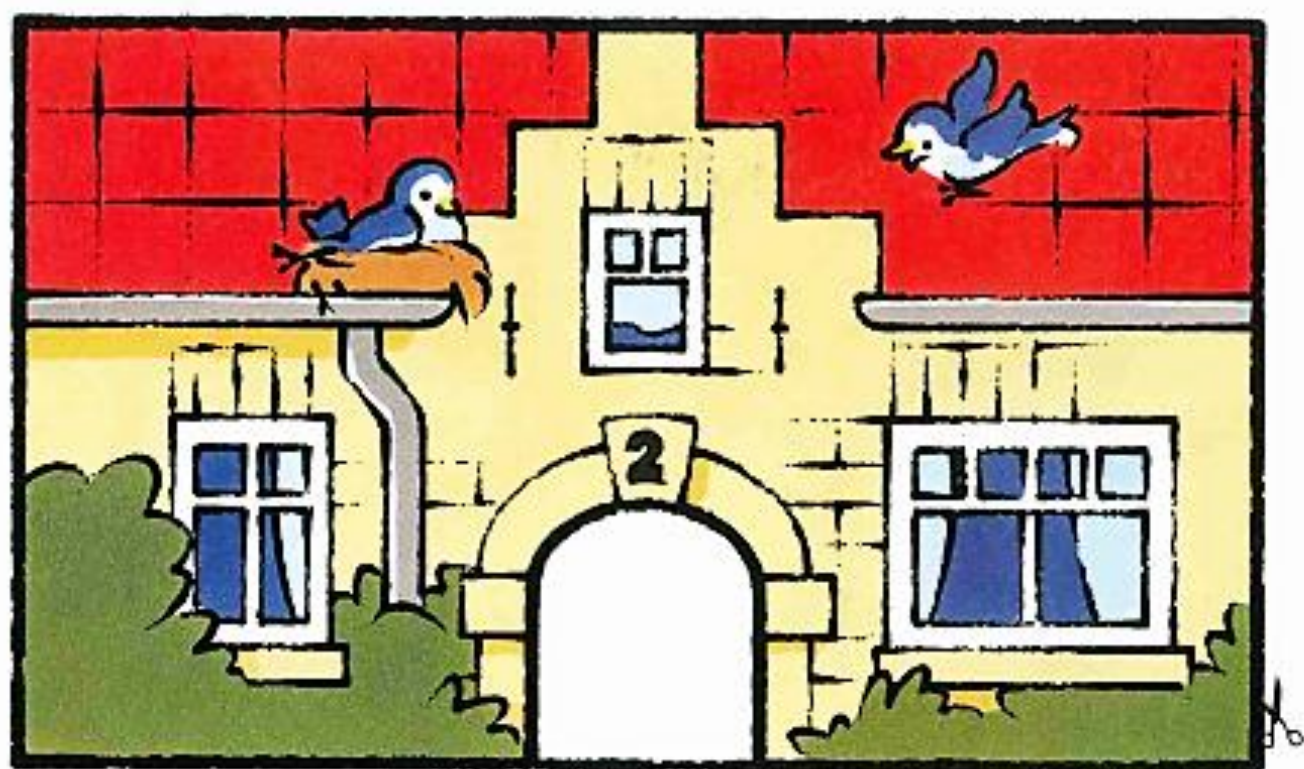



## Wat hoort bij wie?

Op onderstaande link vinden jullie een leuk spelletje.  
Sleep het prentje in het juiste vakje en druk daarna op het rechter pijltje in de hoek rechts onder.

<https://www.tinytap.it/activities/g3hcj/play/>

